

Üroloji

Urology

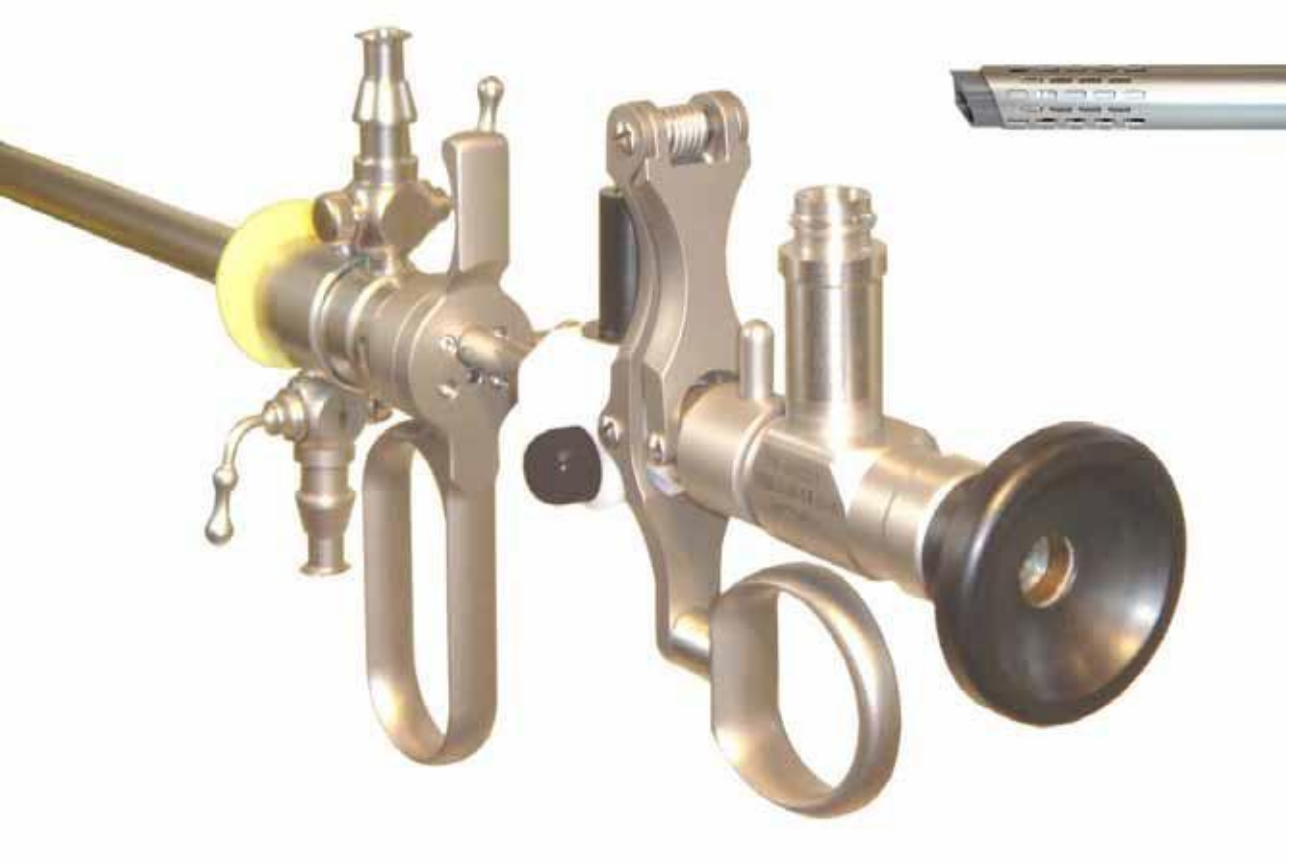

Üroloji / Urology

İçindekiler - Üroloji

SAYFA

Table of contents - Urology

Page

Sistoskopi

Cystoscopy

3-12

Rezektoskopi

Resectoscopy

13-20

Üretroskopi

Urethroscopy

21-24

İnce Rezektoskop

Thin Resectoscope

25-28

Uretero-Renoskopi

Uretero-Renoscopia

29-32

Pediyatrik Üroloji

Pediatric Urology

33-40

Aksesuaralar

Accessories

41-42

Sistoskopi Cystoscopy

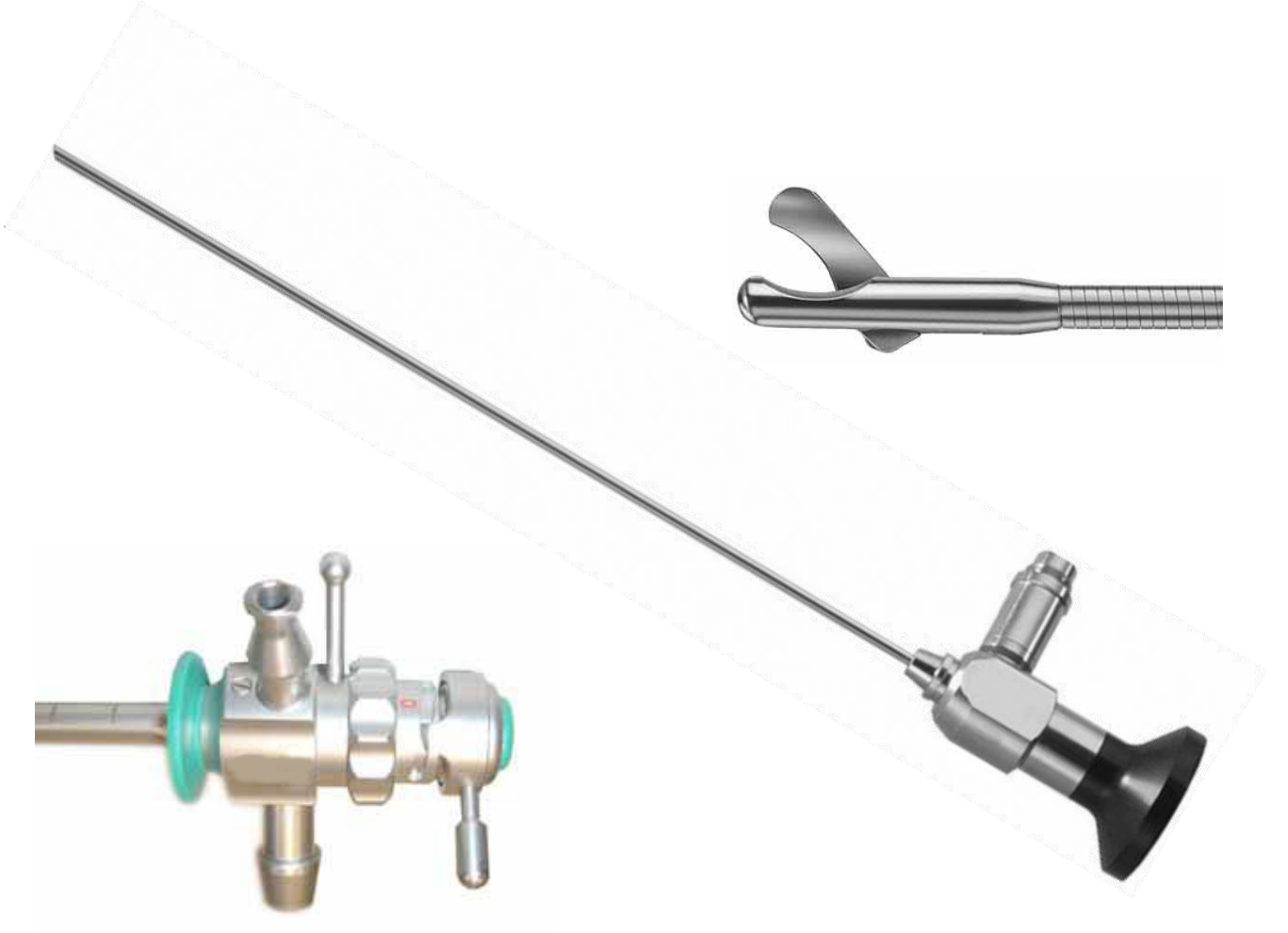

PASLANMAZ ÇELİK

**Sistoskoplara
Cystoscopes**

stainless steel

Tüm Teleskoplar en çok kullanılan markalar ile uyumlu 3 adet farklı konektörler ile donatılmıştır

All telescopes are equipped with 3 different light guide connectors for the most common cables

- ③ Storz®/Olympus®-Adaptör
- ④ Wolf® Adaptör
- ⑤ ACM® Anschluß / Konektör
- ⑥ Storz® Anschluß / Konektör
- ⑦ Okulartrichter / Mercek

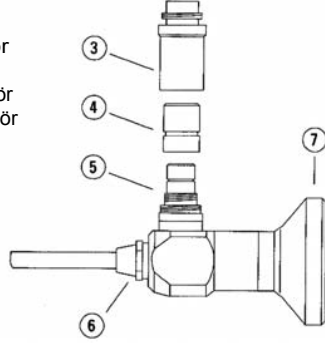

31-00094	Sistoskop, 4mm, Düz 0° Derece, 302 mm , otoklavlanabilir	31-00094	Cystoscope, 4mm, straight forward 0°, 302 mm lenght autoclavable,
31-00095	Sistoskop, 4mm, Öne Eğik 12° derece, 302 mm , otoklavlanabilir	31-00095	Cystoscope, 4mm, forward-oblique 12°, 302 mm lenght, autoclavable,
31-00096	Sistoskop, 4mm, Öne Eğik 30°, 302 mm , otoklavlanabilir	31-00096	Cystoscope, 4mm, forward-oblique 30°, 302 mm lenght, autoclavable,
31-00097	Sistoskop, 4mm, Öne Eğik ,70°, 302 mm lang, otoklavlanabilir	31-00097	Cystoscope, 4mm, forward-oblique 70°, 302 mm lenght, autoclavable,

Fiber Işık Kabloları
Fibre Light cables



Fiber Işık Kabloları 2,3 bar (134 °C) de otoklavlanabilir

Fibre Light cables, autoclavable at 2,3 bar

Ekipman-Adaptörü Equipment adapter	Endoskop-Adaptörü Endoscope adapter	Ø [mm]	Uzunluk 1800 mm Length 1800 mm	Uzunluk 2300 mm Length 2300 mm	Uzunluk 3000 mm Length 3000 mm
ENDOSER / Storz	ENDOSER / Storz	4,8	31-00200	31-00201	31-00202
ENDOSER / Storz	ENDOSER / Storz	6,0	31-00205	31-00206	31-00207
Winter / Ibe	ENDOSER / Storz	4,8	31-00210	31-00211	31-00212
Winter / Ibe	Winter / Ibe	6,0	31-00215	31-00216	31-00217
Wolf / HSW	Wolf / HSW	4,8	31-00220	31-00221	31-00222
Wolf / HSW	Wolf / HSW	6,0	31-00225	31-00226	31-00227
ACM / British	ACM / British	4,8	31-00230	31-00231	31-00232
ACM / British	ACM / British	6,0	31-00235	31-00236	31-00237

Yüksek Performanslı,

Fiber Işık Kabloları 2,3 bar (134 °C) de otoklavlanabilir

High Power Light cables for Light Sources with
high performance,
autoclavable at 2,3 bar (134°C)

Ekipman-Adaptörü Equipment adapter	Endoskop-Adaptörü Endoscope adapter	Ø [mm]	Uzunluk 1800 mm Length 1800 mm	Uzunluk 2300 mm Length 2300 mm	Uzunluk 3000 mm Length 3000 mm
ENDOSER / Storz	ENDOSER / Storz	4,8	31-00500	31-00501	31-00502
Winter / Ibe	ENDOSER / Storz	4,8	31-00510	31-00511	31-00512
Wolf / HSW	Wolf / HSW	4,8	31-00520	31-00521	31-00522
ACM / British	ACM / British	4,8	31-00530	31-00531	31-00532

**PASLANMAZ
ÇELİK**

Sistoskopi Üretroskopi Kılıfları ,Obturator ile
Cystoscopy - Urethroscopy sheaths with Obturator

stainless steel

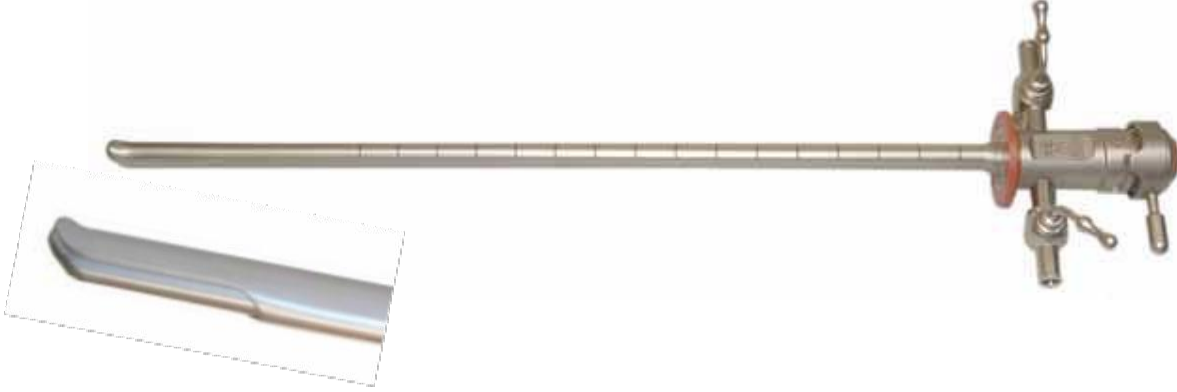

Sisteskop Üretroskop Kılıfları
2 Sabit Musluk ve Obtüratör

Cystoscope - Urethroscope sheath with
2 fixed stopcocks and Obturator

26-02009	15 FR Renk Kodu Siyah
26-02010	17 FR Renk Kodu Sarı
26-02011	19 FR Renk Kodu Yeşil
26-02012	21 FR Renk Kodu Kırmızı
26-02013	23 FR Renk Kodu Mavi
26-02014	25 FR Renk Kodu Beyaz

26-02009	15 Fr. Colour code black
26-02010	17 Fr. Colour code yellow
26-02011	19 Fr. Colour code green
26-02012	21 Fr. Colour code red
26-02013	23 Fr. Colour code blue
26-02014	25 Fr. Colour code white



Sisteskop - Üretroskop kılıfları
Merkez Valf ve Obtüratör

Cystoscope - Urethroscope sheath with
Central valve and Obturator

26-02003	17 FR Renk Kodu Sarı
26-02004	19 FR Renk Kodu Yeşil
26-02005	21 FR Renk Kodu Kırmızı
26-02006	23 FR Renk Kodu Mavi
26-02007	25 FR Renk Kodu Beyaz

26-02003	17 Fr. Colour code yellow
26-02004	19 Fr. Colour code green
26-02005	21 Fr. Colour code red
26-02006	23 Fr. Colour code blue
26-02007	25 Fr. Colour code white



Görüş Obtüratörü , Sisteskop / Üretroskop ile kullanım için

Visual obturator for use with Cystoscope / Urethroscope

26-02040	17 FR Renk Kodu Sarı
26-02041	19 FR Renk Kodu Yeşil
26-02042	21 FR Renk Kodu Kırmızı
26-02043	23 FR Renk Kodu Mavi
26-02044	25 FR Renk Kodu Beyaz

26-02040	17 Fr. Colour code yellow
26-02041	19 Fr. Colour code green
26-02042	21 Fr. Colour code red
26-02043	23 Fr. Colour code blue
26-02044	25 Fr. Colour code white

PASLANMAZ
ÇELİK

Teleskop Köprüleri
Telescope - bridges

stainless steel



26-02023

Sistoskopi / Üretroskopi Adaptör
(Dişi Üretroskop)

26-02023

Cysto- / Urethroscopy
adapter for female
Urethroscope



26-02030

Albarran çalışma Elemanı,
Deflektör ve bir çalışma kanalı dahil

26-02030

Albarran working element
with deflector and
one working channel

26-02031

Albarran çalışma Elemanı,
Deflektör ve iki çalışma kanalı dahil

26-02031

Albarran working element
with deflector and
two working channels

Obtüratörlü Kılıflar Sheath with obturator		Renk Kodu Color code	Döndürme Mekanizması Deflecting mechanism		Teleskop Köprüsü Telescope bridge	
			26-02030	26-02031	26-02021	26-02022
26-02010	17 Fr.	sarı/yellow	-	-	1x5	1x5
		sarı/yellow	-	-	-	-
26-02011	19 Fr.	yeşil/green	1x5	1x5	1x6	1x6
		yeşil/green	-	2x4	-	2x5
26-02012	21 Fr.	kırmızı/red	1x6	1x6	1x7	1x7
		kırmızı/red	-	2x5	-	2x6
26-02013	23 Fr.	mavi/blue	1x9	1x9	1x10	1x10
		mavi/blue	-	2x6	1	2x7
26-02014	25 Fr.	beyaz/white	1x10	1x10	1x12	1x12
		beyaz/white	-	2x8	-	2x9

PASLANMAZ
ÇELİK

Teleskop Köprüleri
Telescope - bridges

stainless steel



26-02020 . Tanı için teleskop Köprüsü
| U_ñna U_UbU_x\Uf]ce

26-02020

Telescope bridge for diagnostic
without working channel



26-02021 ` Teleskop Köprüsü
1 çalışma kanalı dahil

26-02021

Telescope bridge with one
working channel



26-02022 Teleskop Köprüsü
2 çalışma kanalı dahil

26-02022

Telescope bridge with two
working channels

PASLANMAZ
ÇELİK

Optik Aletler
Optical Instruments

stainless steel



26-02051

Taş Kavrayıcı Forseps
çift hareketli çeneler

26-02051

Stone grasping forceps,
double action jaws



26-02052

Kanca makas,
çift hareketli çeneler

26-02052

Hook scissors,
double action jaws



26-02053

Kaşık şekil Kavrayıcı Forseps
çift hareketli çeneler

26-02053

Spoon grasping forceps,
double action jaws



26-02054

Biyopsi Panç,
çift hareketli çeneler

26-02054

Biopsy punch,
double action jaws



26-02055

Taş Forsepsi

26-02055

Stone forceps



26-02056

Altan Kavrayıcı Forseps,
çift hareketli çeneler

26-02056

Grasping forceps from bottom,
double action jaws



26-02057

Biyopsi Forseps, kısa çene parçaları
2,3 mm 30° Optikler için
çift hareketli çeneler

26-02057

Biopsy forceps with short jaw
parts 2,3 mm for 30° Optic
double action jaws





İsteğe göre izole edilebilir.

Insulated sheath on request

40 cm Çalışma Uzunluğu

40 cm working length



26-00621	Biyopsi forseps, çift çene hareketi, 10 Fr		26-00621	Biopsy forceps, double action jaw 10 Fr.
26-00622	Biyopsi forseps, çift çene hareketi, 10 Fr yarı esnek		26-00622	Biopsy forceps, double action jaw, semi rigid, 10 Fr.
26-00610	Biyopsi forseps, çift çene hareketi, 7 Fr		26-00610	Biopsy forceps, double action jaw 7 Fr.
26-00623	Biyopsi forseps,yarı esnek çift çene hareketi, 7 Fr		26-00623	Biopsy forceps, double action jaw, semi rigid, 7 Fr.
26-00618	Biyopsi forseps, çift çene hareketi, 5 Fr		26-00618	Biopsy forceps, double action jaw 5 Fr.
26-00624	Biyopsi forseps,yarı esnek çift çene hareketi, 5 Fr		26-00624	Biopsy forceps, double action jaw, semi rigid, 5 Fr.
26-00625	Biyopsi forseps, çift çene hareketi, 3 Fr		26-00625	Biopsy forceps, double action jaw 3 Fr.
26-00626	Biyopsi forseps,yarı esnek çift çene hareketi, 3 Fr		26-00626	Biopsy forceps, double action jaw, semi rigid, 3 Fr.
26-00601	Kavrayıcı Forseps, çift çene hareketi, 7 Fr		26-00601	Grasping forceps, double action jaw 7 Fr.
26-00627	Kavrayıcı Forseps,yarı esnek çift çene hareketi, 7 Fr		26-00627	Grasping forceps, double action jaw, semi rigid, 7 Fr.
26-00615	Kavrayıcı Forseps, çift çene hareketi, 5 Fr		26-00615	Grasping forceps, double action jaw 5 Fr.
26-00628	Kavrayıcı Forseps,yarı esnek, çift çene hareketi, 5 Fr		26-00628	Grasping forceps, double action jaw, semi rigid, 5 Fr.

İsteğe göre izole edilebilir.
Insulated sheath on request

40 cm Çalışma Uzunluğu
40 cm working length



26-00629	Makas, tek çene hareketi 10 Fr.	26-00629	Scissors, single action jaw 10 Fr.
26-00630	Schere, tek çene hareketi yarı esnek, 10 Fr.	26-00630	Scissors, single action jaw, semi rigid, 10 Fr.
26-00631	Schere, tek çene hareketi 7 Fr.	26-00631	Scissors, single action jaw 7 Fr.
26-00632	Schere, tek çene hareketi yarı esnek, 7 Fr.	26-00632	Scissors, single action jaw, semi rigid, 7 Fr.
26-00612	Schere, tek çene hareketi 5 Fr.	26-00612	Scissors, single action jaw 5 Fr.
26-00633	Makas tek çene hareketi yarı esnek, 5 Fr.	26-00633	Scissors, single action jaw, semi rigid, 5 Fr.



26-00634	Kanca makas, tek çene hareketi 10 Fr.	26-00634	Hook scissors, single action jaw 10 Fr.
26-00635	Kanca makas, tek çene hareketi 7 Fr.	26-00635	Hook scissors, single action jaw 7 Fr.



26-00636	Makas, çift çene hareketi 7 Fr.	26-00636	Scissors, double action jaw 7 Fr.
----------	------------------------------------	----------	--------------------------------------

İsteğe göre izole edilebilir.

Insulated sheath on request

40 cm Çalışma Uzunluğu
40 cm working length



26-00637	Oval Kaşık, Tırtıklı 10 CH	26-00637	Oval cup, serrated 10 Fr.
26-00638	Oval Kaşık, Tırtıklı, Yarı esnek, 10 Fr.	26-00638	Oval cup, serrated, semi rigid 10 Fr.
26-00639	Oval Kaşık, Tırtıklı, 7 Fr.	26-00639	Oval cup, serrated 7 Fr.
26-00640	Oval Kaşık, Tırtıklı, Yarı esnek, 7 Fr.	26-00640	Oval cup, serrated, semi rigid 7 Fr.
26-00641	Oval Kaşık, Tırtıklı, 5 Fr.	26-00641	Oval cup, serrated 5 Fr.
26-00642	Oval Kaşık, Tırtıklı, Yarı esnek, 5 Fr.	26-00642	Oval cup, serrated, semi rigid, 5 Fr.
26-00643	Oval Kaşık, Tırtıklı, 7 Fr.	26-00643	Oval cup, serrated 7 Fr.
26-00644	Biyopsi Forseps, Tek Çene hareketi, 7 Fr.	26-00644	Biopsy forceps, single action jaws 7 Fr.
26-00645	Kavrayıcı Forseps Tek Çene hareketi, 7 Fr.	26-00645	Grasping forceps, single action jaws 7 Fr.

TAŞ SEPETLERİ

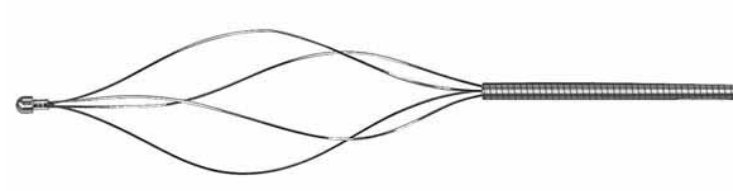

26-00648

Taş Sepeti` 3 Fr.
uzunluk 60 cm

26-00648

Stone basket 3 Fr.,
length 60 cm

26-00649

Taş Sepeti 3 Fr.
uzunluk 120 cm

26-00649

Stone basket 3 Fr.,
length 120 cm

26-00650

Taş Sepeti 5 Fr.
uzunluk 60 cm

26-00650

Stone basket 5 Fr.,
length 60 cm

Rezektoskopi Resectoscopy

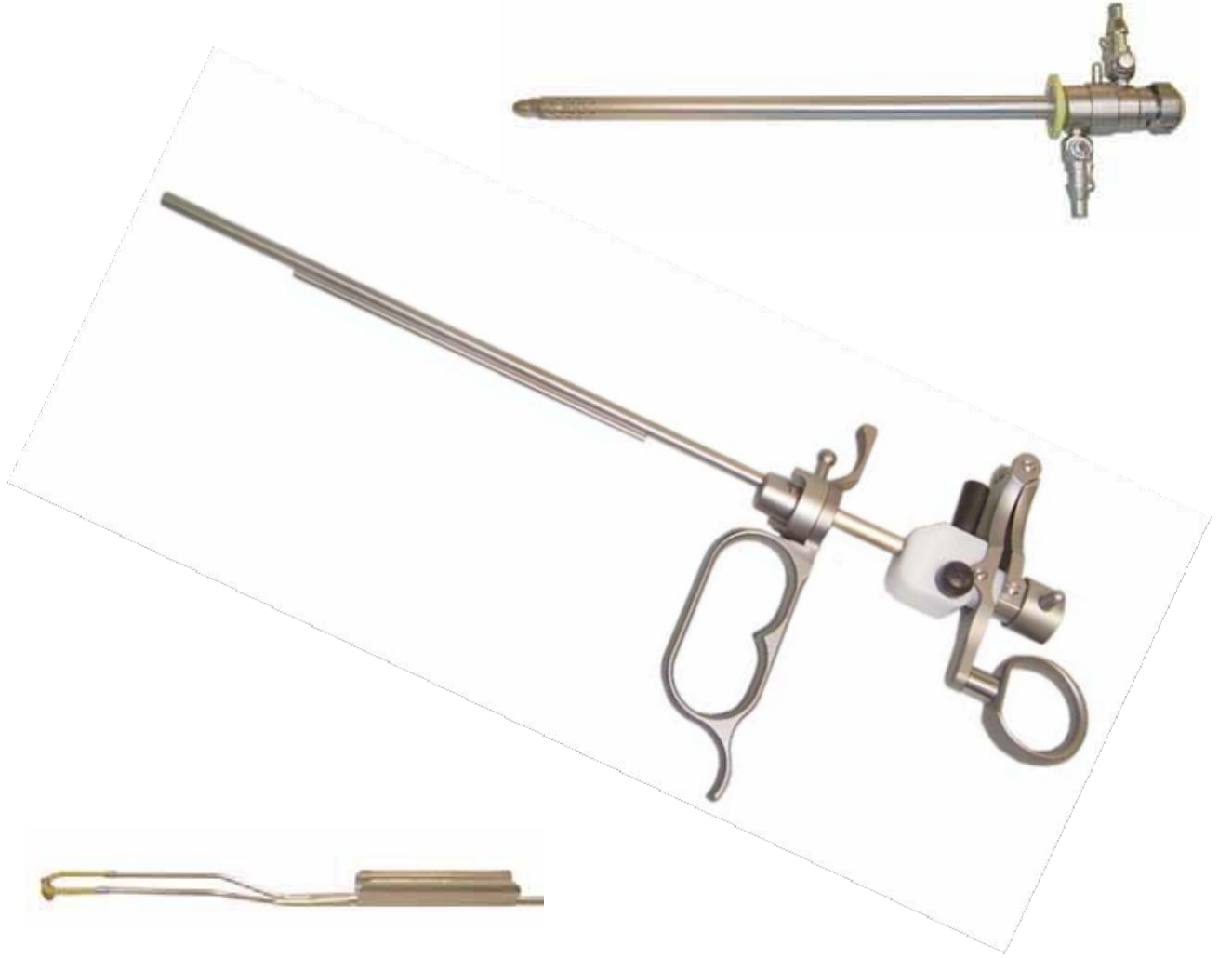

Çalışma Elemanları
Working elements



26-02102

Çalışma elemanı, pasif
Paslanmaz Çelik

26-02102

Working element, passive,
stainless steel



26-02112

Çalışma elemanı, aktif
Paslanmaz Çelik

26-02112

Working element, active,
stainless steel

Monopolar Elektrotlar, Tek köklü
Unipolar Electrodes single stem



26-02202	Loop elektrot, düz 24 FR.	26-02202	Loop electrode, straight 24 Fr.
----------	------------------------------	----------	------------------------------------

26-02219	Loop elektrot, düz 27 FR.	26-02219	Loop electrode, straight 27 Fr.
----------	------------------------------	----------	------------------------------------



26-02200	Loop elektrot 30° kivrımlı, 24 FR.	26-02200	Loop electrode curved 30° 24 Fr.
----------	---------------------------------------	----------	-------------------------------------

26-02220	Loop elektrot 30° Kivrımlı, 27 FR.	26-02220	Loop electrode curved 30° 27 Fr.
----------	---------------------------------------	----------	-------------------------------------



26-02221	Loop elektrot 90° kivrımlı, 24 CH	26-02221	Loop electrode curved, 90° 24 Fr.
----------	--------------------------------------	----------	--------------------------------------

26-02222	Loop elektrot 90° kivrımlı, 27 CH	26-02222	Loop electrode curved, 90° 27 Fr.
----------	--------------------------------------	----------	--------------------------------------



26-02204	Küre Elektrot 3 mm, 24 CH	26-02204	Ball electrode 3 mm, 24 Fr.
----------	------------------------------	----------	--------------------------------

26-02223	Küre Elektrot 3 mm, 27 CH	26-02223	Ball electrode 3 mm, 27 Fr.
----------	------------------------------	----------	--------------------------------



26-02205	Küre Elektrot 5 mm, 24 CH	26-02205	Ball electrode 5 mm, 24 Fr.
----------	------------------------------	----------	--------------------------------

26-02224	Küre Elektrot 5 mm, 27 CH	26-02224	Ball electrode 5 mm, 27 Fr.
----------	------------------------------	----------	--------------------------------

Renk Kodu : sarı = 24 FR, kahverengi = 27 CH

Colour code: yellow = 24 Fr., brown = 27 Fr.

Monopolar Elektrotlar, Tek köklü
Unipolar Electrodes single stem



26-02206	Silidir Elektrot 3 mm, 24 Fr	26-02206	Roller electrode 3 mm, 24 Fr.
----------	---------------------------------	----------	----------------------------------

26-02225	Silidir Elektrot 3 mm, 27 Fr	26-02225	Roller electrode 3 mm, 27 Fr.
----------	---------------------------------	----------	----------------------------------



26-02207	Silidir Elektrot 5 mm, 24 Fr.	26-02207	Roller electrode 5 mm, 24 Fr.
----------	----------------------------------	----------	----------------------------------

26-02226	Silidir Elektrot 5 mm, 27 Fr.	26-02226	Roller electrode 5 mm, 27 Fr.
----------	----------------------------------	----------	----------------------------------



26-02217	Buharlaştırma elektrotu 3 mm, 24 Fr.	26-02217	Vaporisation electrode 3 mm, 24 Fr.
----------	---	----------	--

26-02227	Buharlaştırma elektrotu 3 mm, 27 Fr.	26-02227	Vaporisation electrode 3 mm, 27 Fr.
----------	---	----------	--



26-02218	Buharlaştırma elektrotu 5 mm, 24 Fr.	26-02218	Vaporisation electrode 5 mm, 24 Fr.
----------	---	----------	--

26-02228	Buharlaştırma elektrotu 5 mm, 27 Fr.	26-02228	Vaporisation electrode 5 mm, 27 Fr.
----------	---	----------	--

Renk Kodu: sarı = 24 Fr., kahverengi = 27 Fr.

Colour code: yellow = 24 CH, brown = 27 CH

Monopolar Elektrotlar , tek köklü
Unipolar Electrodes single stem



26-02215

Başak uçlu 3 mm,
24 Fr.

26-02215

Spike electrode 3 mm,
24 Fr.

26-02229

Başak uçlu 3 mm,
27 Fr.

26-02229

Spike electrode 3 mm,
27 Fr.

26-02216

Başak uçlu elektrot, 5 mm,
24 Fr.

26-02216

Spike electrode 5 mm,
24 Fr.

26-02230

Başak uçlu elektrot, 3 mm, 5 mm,
27 Fr.

26-02230

Spike electrode 5 mm,
27 Fr.

26-02208

Koni uçlu elektrot 3 mm,
24 Fr.

26-02208

Conical electrode 3 mm,
24 Fr.

26-02231

Koni uçlu elektrot 3 mm,
27 Fr.

26-02231

Conical electrode 3 mm,
27 Fr.

26-02203

Bıçak uçlu elektrot,kıvrımlı
24 Fr.

26-02203

Knife electrode curved,
24 Fr.

26-02232

Bıçak uçlu elektrot,kıvrımlı
27 Fr.

26-02232

Knife electrode curved,
27 Fr.

26-02233

Kemer Uçlu Elektrot , 0° Optik
24 Fr.

26-02233

Band electrode, 0° Optic
24 Fr.

26-02234

Kemer Uçlu Elektrot, 0° Optik
27 Fr.

26-02234

Band electrode, 0° Optic
27 Fr.

Renk Kodları: sarı = 24 Fr. , kahverengi = 27 Fr.

Colour code: yellow = 24 Fr., brown = 27 Fr.

Monopolar Elektrotlar, tek köklü
Unipolar Electrodes single stem



26-02235 Kemer uçlu Elektrot, 30° Optik 24 Fr. 26-02235 Band electrode, 30° Optic 24 Fr.

26-02236 Kemer uçlu Elektrot, 30° Optik 27 Fr. 26-02236 Band electrode, 30° Optic 27 Fr.



26-02237 Kemer uçlu Elektrot, Buharlaştırma 24 Fr. 26-02237 Band electrode, vaporisation 24 Fr.

26-02228 Kemer uçlu Elektrot, Buharlaştırma 27 Fr. 26-02228 Band electrode, vaporisation 27 Fr.

Farbkennung: gelb = 24 Fr. , braun = 27 Fr.

Colour code: yellow = 24 Fr., brown = 27 Fr.



26-02240 Elektrotlar için sterilize etme kutusu 26-02240 Sterilization box for electrodes



26-02250 HF-Kablo 4 mm Berchtold, Martin, Aesculap için 26-02250 HF cable for Aesculap, Berchtold, Martin, 4 mm



26-02251 HF-Kablo 5 mm , Storz, Erbe için 26-02251 HF cable for Storz, Erbe, 5 mm



26-02252 HF-Kablo ,8 mm Bowie, Valleylab için 26-02252 HF cable for Valleylab, Bowie, 8 mm

Rezektoskop Kılıfı
Resectoscope sheath



26-02120	Rezektoskop Kılıfı set: 26 Fr. Sürekli akış için Obtüratörlü, Esnemez	26-02020	Resectoscope sheath complete for continuous flow with obturator, rigid, 26 Fr.
26-02142	Dış Kılıf , 26 Fr. Vakumlama için delikli	26-02142	Outer sheath with perforation for suction, 26 Fr.
26-02122	İç Kılıf , Esnemez , Seramik izolasyonlu, 26 Fr.	26-02122	Inner sheath rigid with ceramic insulation, 26 Fr.
26-02117	Standart Obtüratör 24 / 26 Fr.	26-02117	Standard obturator for 24 / 26 Fr.
26-02140	Rezektoskop Kılıfı set: 28,5 Fr. Sürekli akış için Obtüratörlü, Esnemez	26-02140	Resectoscope sheath complete for continuous flow with obturator, rigid, 28,5 Fr.
26-02143	Dış Kılıf , 28,5 Fr. Vakumlama için delikli	26-02143	Outer sheath with perforation for suction, 28,5 Fr.
26-02144	İç Kılıf , Esnemez , Seramik izolasyonlu, 28,5 Fr.	26-02144	Inner sheath rigid with ceramic insulation, 28,5 Fr.
26-02118	Standart Obtüratör 28,5 Fr.	26-02118	Standard obturator for 28,5 Fr.
Resimsiz:		Without illustration:	
26-02121	Rezektoskop Kılıfı set: 26 Fr. Sürekli akış için Obtüratörlü, Dönebilen	26-02121	Resectoscope sheath complete for continuous flow with obturator, rotatable, 26 Fr.
26-02141	Rezektoskop Kılıfı set: 28,5 Fr. Sürekli akış için Obtüratörlü, Dönebilen	26-02141	Resectoscope sheath complete for continuous flow with obturator, rotatable, 28,5 Fr.
26-02150	Dış Kılıf , 28,5 Fr. Vakumlama için delikli	26-02150	Outer sheath with perforation for suction, 28,5 Fr.
26-02151	İç Kılıf , Dönebilen , Seramik izolasyonlu, 28,5 Fr.	26-02151	Inner sheath rotatable with ceramic insulation, 28,5 Fr.
26-02118	Standart Obtüratör 28,5 Fr.	26-02118	Standard obturator for 28,5 Fr.

Rezektoskop Kılıfı
Resectoscope sheath



26-02146	Rezektoskop Kılıfı Obtüratör hariç Merkez valfli, 24 Fr.	26-02146	Resectoscope sheath with central valve without obturator, 24 Fr.
26-02147	Rezektoskop Kılıfı Obtüratör hariç Merkez valfli, 27 Fr.	26-02147	Resectoscope sheath with central valve without obturator, 27 Fr.



26-02148	Rezektoskop Kılıfı Obtüratör hariç 1 musluklu , 24 Fr.	26-02148	Resectoscope sheath without obturator, 1 stopcock, 24 Fr.
26-02149	Rezektoskop Kılıfı Obtüratör hariç 1 musluklu , 27 Fr	26-02149	Resectoscope sheath 27 Fr. 1 stopcock, without obturator,

Obtüratörler
Obturator



26-02130	Esnek Obtüratör, 24 / 26 Fr.	26-02130	Flexible obturator, 24 / 26 Fr.
26-02131	Esnek Obtüratör, 27 / 28,5 Fr.	26-02131	Flexible obturator, 27 / 28,5 Fr.



26-02117	Standart Obtüratör, 24 / 26 Fr.	26-02117	Standard obturator, 24 / 26 Fr.
26-02118	Standart Obtüratör, 27 / 28,5 Fr.	26-02118	Standard obturator, 27 / 28,5 Fr.



26-02135	Görüş Obtüratörü, 24 / 26 Fr.	26-02135	Visual obturator, 24 / 26 Fr.
26-02136	Görüş Obtüratörü, 27 / 28,5 Fr.	26-02136	Visual obturator, 27 / 28,5 Fr.



26-02137	Görüş Obtüratörü 24 / 26 Fr 1 enstrüman kanalı Çalışma Kanallı 5 Fr.	26-02137	Visual obturator 24 / 26 Fr. with 1 instrument channel, working channel 5 Fr.
26-02138	Sichtobturator 27 / 28,5 CH mit 1 enstrüman kanalı Çalışma Kanallı 7 Fr.	26-02138	Visual obturator 27 / 28,5 Fr. with 1 instrument channel, Working channel 7 Fr.

Üretroskopi Urethrotoscopy



Çalışma Elemanı
Working elements



26-02102

Çalışma Elemanı , Pasif
Paslanmaz çelik

26-02102

Working element, passive,
stainless steel

Üretrotom Kılıfı
Urethrotom sheaths



26-02400

Üretrotom Kılıfı 21 Fr.
Araç Kanallı 5 Fr., Obtüratör Hariç,

26-02400

Urethrotom sheath 21 Fr. with
instrument channel 5 Fr. without
obturator



26-02403

Ek kılıf,
Balon kateterinin yerleştirilmesi için yan tarafı açık
26-02400 no.lu ürün yerleştirilebilir.

26-02403

Additional sheath sidwise open
for laying of a balloon catheter,
sidwise deferrable on 26-02400



26-02404

Dış Üretrotom kılıfı
Sürekli akış için 1 musluklu

26-02404

Outer Urethrotom sheath with
1 tap for continuous flow

Üretrotom kılıfları için **Obtüratörler** (Yetişkin /0° Optikler /4mm,302mm için)
Obturator for Urethrotome sheaths (for adults/0°Optics/4mm,302mm)



26-02401

Standart Obtüratör, 21Fr. Kılıf için

26-02401

Standard obturator for sheath 21 Fr.

26-02405

İçbükey Obtüratör 5 Fr.
5 Fr. Araç Kanalları İçin

26-02405

obturator concave for instrument
channel 5 Fr.



26-02407

Optik obtüratörü, Üretrotom için.

26-02407

Visual obturator, for Urethrotome







26-02408

Optik köprüsü, Üretrotom için

26-02408

Visual bridge, for Urethrotome

Üretrotomi için Soğuk Bıçaklar (Yetişkin /0° Optikler/4mm,302mm için)
Cold knives for Urethrotomy (for adults/0°Optics/4mm,302mm)

26-02410	Soğuk Bıçak,düz		26-02410	Cold knife, straight
26-02411	Soğuk Bıçak, yuvarlak		26-02411	Cold knife, round
26-02412	Soğuk Bıçak, tırtıklı		26-02412	Cold knife, straight, serrated
26-02413	Soğuk Bıçak, dairesel		26-02413	Cold knife, circular
26-02414 S	Soğuk Bıçak, Kanca uç		26-02414	Cold knife, hook-shaped

İnce Rezektoskoplar thin Resectoscope



Çalışma Elemanları (19/22 FR , 2,9mm/12° Optikler İçin)
Working elements (19/22 CH for 2,9mm/12° optics)



26-02450

Çalışma elemanı, pasif

26-02450

Working element passive



26-02451

Çalışma Elemanı, aktif

26-02451

Working element active

Sistoskop
Cystoscope

Bütün teleskoplar, en çok kullanılan markalara uyumlu
3 farklı konektörler ile donatılmışlardır.

All telescopes are equipped with 3 different
light guide connectors for the most
common cables

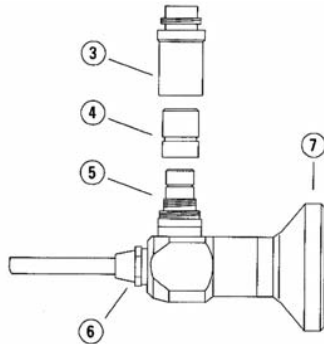

31-00067

Histeroskop, 2,7mm,
düz, 30° ,302 mm uzunluk
otoklavlanabilir

31-00067

Hysteroscope, 2,7mm,
straight forward 30°,
302 mm length autoclavable,

Rezektoskop Kılıfları (19/22 Fr., 2,9mm/12° Optikler için)
Resectoscope sheath (19/22 CH for 2,9mm/12° optics)



26-02460	Rezektoskop Kılıfı 19 Fr. Obtüratör hariç	26-02460	Resectoscope sheath 19 Fr. without obturator
26-02461	Standart obtüratör 19 Fr Kılıf için	26-02461	Standard obturator for 19 Fr. sheath

Görüş Obtüratörü (19/22 Fr. 2,9mm/12° Optikler için)
Visual obturators (19/22 CH for 2,9mm/12° optics)



26-02462	Sürekli akış içinkılıf seti,esnemez Obtüratör hariç, 19 CH / 22 Fr.	26-02462	Sheath for continuous flow complete, rigid, without obturator, 19 Fr. / 22 Fr.
26-02463	Dış Kılıf Vakum için delikli , 22 Fr.	26-02463	Outer sheath with perforation for suction, 22 Fr.
26-02464	İç Kılıf, esnemez Seramik izolasyonlu, 19 Fr.	26-02464	Inner sheath rigid with ceramic insulation, 19 Fr.
26-02465	Standart Obtüratör 19 Fr. kılıf için	26-02465	Standard obturator for 19 Fr.
Resimsiz:		Without illustration:	
26-02466	Sürekli akış içinkılıf seti,Dönebilen Obtüratör hariç, 19 Fr. / 22 Fr.	26-02466	Sheath for continuous flow, rotatable, without obturator, 19 Fr. / 22 Fr.
26-02467	Dış Kılıf Vakum için delikli , 22 Fr.	26-02467	Outer sheath with perforation for suction, 22 Fr.
26-02468	İç Kılıf, dönebilen Seramik izolasyonlu, 19 Fr.	26-02468	Inner sheath rotatable with ceramic insulation, 19 Fr.
26-02469	Standart Obtüratör 19 Fr.	26-02469	Standard obturator for 19 Fr.

Görüş Obtüratörü (19/22 CH , 2,9mm/12° Optikler için)
Visual obturators (19/22 CH for 2,9mm/12° optics)



26-02470	Görüş Obtüratörü, 19/22 Fr.	26-02470	Visual obturator, 19/22 Fr.
----------	-----------------------------	----------	-----------------------------

Monopolar Elektrotlar ,tek köklü (19/22 Fr. 2,9mm/12° Optikler için)
Unipolar Electrodes single stem (19/22 CH for 2,9mm/12° optics)

26-02480

Loop Elektrot,
19 Fr.



26-02480

Loop electrode,
19 Fr.

26-02481

Loop Elektrot, kıvrımlı
19 Fr.



26-02481

Loop electrode curved,
19 Fr.

26-02482

Küre Elektrot 3 mm,
19 Fr.



26-02482

Ball electrode 3 mm,
19 Fr.

26-02483

Silindir uçlu 3 mm,
19 Fr.



26-02483

Roller electrode 3 mm
19 Fr.

26-02484

Bıçak uçlu
19 Fr.



26-02484

Knife electrode curved,
19 Fr.

Üretero-Renoskopi Uretero-Renoscropy

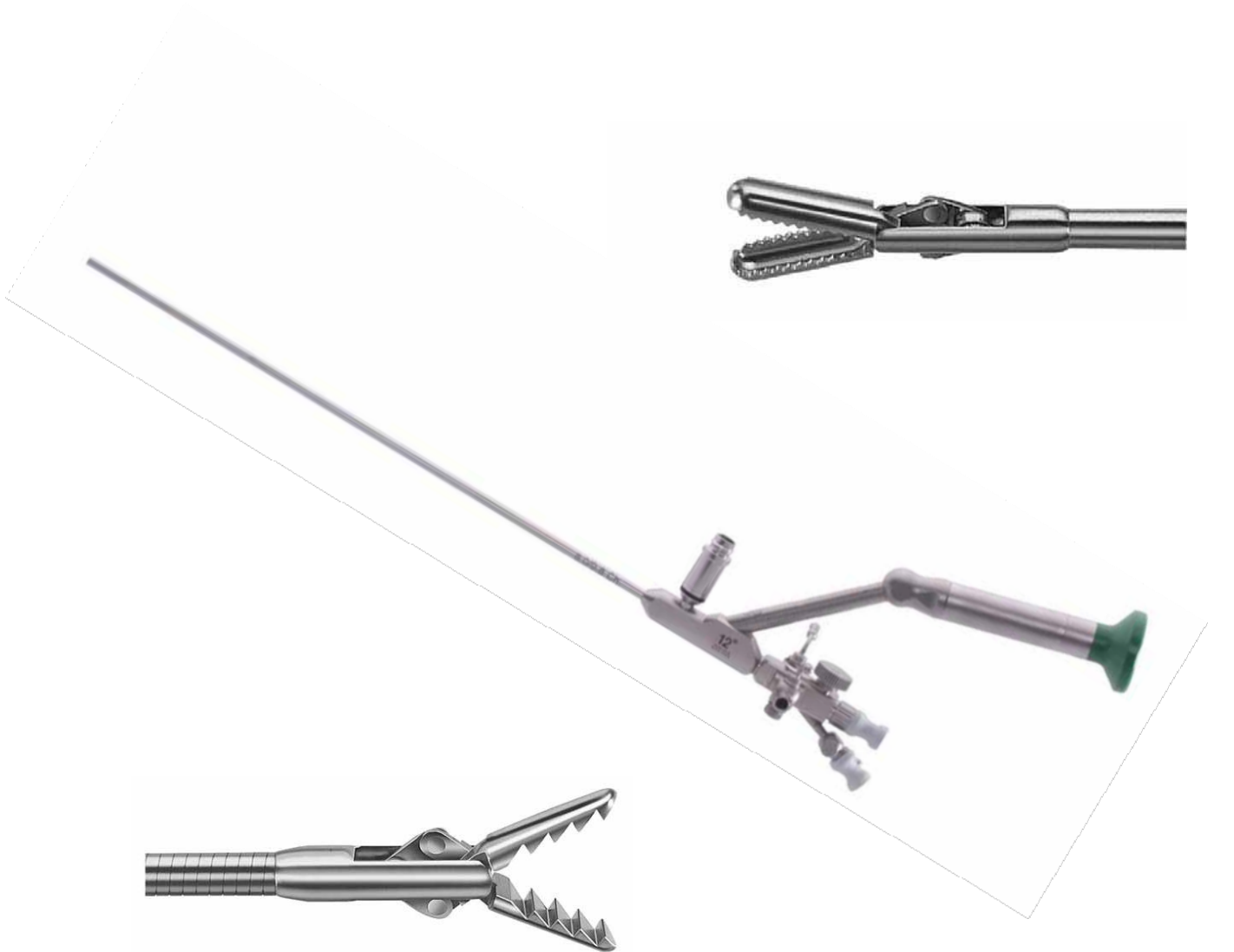

9B8CG9F 'y fYHfc!F Ybcg_cdfI F Gz'W/b] 'y f' bžA ~_Ya a Y'; " f' bh' j Y? i ``Ubñ `ñHUGUfñ
ENDOSER Uretero-renoscopes are a new development with a perfect view and practical design

otoklavlanabilir



31-00130

Üretero-Renoskop,
Diyametre: 8 Fr. / 9,8 Fr.
Çalışma Kanalı 5 Fr.
Uzunluk 315 mm

31-00130

Uretero-Renoscope
diameter 8 Fr. / 9,8 Fr.
working channel 5 Fr.,
length 315 mm

31-00131

Üretero-Renoskop,
Diyametre: 8 Fr. / 9,8 Fr.
Çalışma Kanalı 5 Fr.
Uzunluk 430 mm

31-00131

Uretero-Renoscope
diameter 8 Fr. / 9,8 Fr.
working channel 5 Fr.
length 430 mm

otoklavlanabilir



31-00132

Üretero-Renoskop, açılı kavrama
Diyametre: 8 CH / 9,8 CH
Çalışma Kanalı: 5 Fr.,
Uzunluk 315 mm

31-00132

Uretero-Renoscope angular insight
diameter 8 Fr. / 9,8 Fr.
working channel 5 Fr.
length 315 mm

31-00133

Üretero-Renoskop, açılı kavrama
Diyametre: 8 CH / 9,8 CH
Çalışma Kanalı: 5 Fr.,
Uzunluk 430 mm

31-00133

Uretero-Renoscope angular insight
diameter 8 Fr. / 9,8 Fr.
working channel 5 Fr.
length 430 mm

Kavrayıcı Forsepsler, Taşlar ve kırıntılar için, esnek, yarı-esnek, yaylı /yaysız
Grasping forceps for stones and fragments, flexible, semi-rigid with or without spring

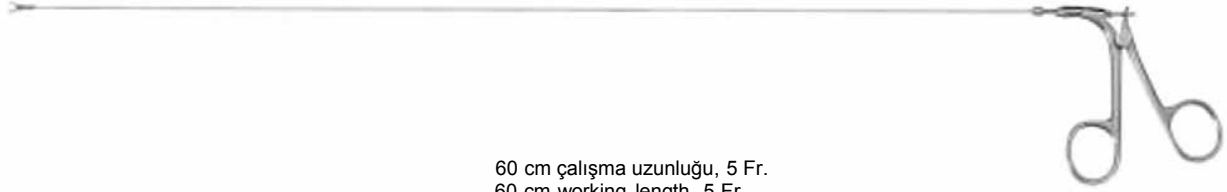

60 cm çalışma uzunluğu, 5 Fr.
60 cm working length, 5 Fr.



26-00651	Kavrayıcı Forsepsler, esnek, yaysız	26-00651	Grasping forceps, flexible, without spring
26-00652	Kavrayıcı Forsepsler, esnek, yaylı	26-00652	Grasping forceps, flexible, with spring
26-00653	Kavrayıcı Forsepsler, yarı esnek, yaysız	26-00653	Grasping forceps, semi-rigid, without spring
26-00654	Kavrayıcı Forsepsler, yarı esnek, yaylı	26-00654	Grasping forceps, semi-rigid, with spring



26-00655	Kavrayıcı Forsepsler, esnek, yaysız	26-00655	Grasping forceps, flexible, without spring
26-00656	Kavrayıcı Forsepsler, esnek, yaylı	26-00656	Grasping forceps, flexible, with spring
26-00657	Kavrayıcı Forsepsler, yarı esnek, yaysız	26-00657	Grasping forceps, semi-rigid, without spring
26-00658	Kavrayıcı Forsepsler, yarı esnek, yaylı	26-00658	Grasping forceps, semi-rigid, with spring



26-00659	Kavrayıcı Forsepsler, esnek, yaysız	26-00659	Grasping forceps, flexible, without spring
26-00660	Kavrayıcı Forsepsler, esnek, yaylı	26-00660	Grasping forceps, flexible, with spring
26-00661	Kavrayıcı Forsepsler, yarı esnek, yaysız	26-00661	Grasping forceps, semi-rigid, without spring
26-00662	Kavrayıcı Forsepsler, yarı esnek, yaylı	26-00662	Grasping forceps, semi-rigid, with spring

Kavrayıcı Forsepsler, Taşlar ve kırıntılar için, esnek, yarı.esnek, yaylı /yaysız
Grasping forceps for stones and fragments, flexible, semi-rigid with or without spring

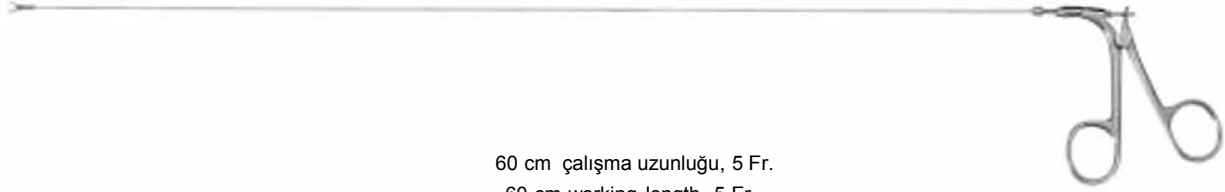

60 cm çalışma uzunluğu, 5 Fr.
60 cm working length, 5 Fr.



26-00616	Kavrayıcı Forseps, esnek , yaysız	26-00616	Grasping forceps, flexible, without spring
26-00663	Kavrayıcı Forseps, esnek , yaylı	26-00663	Grasping forceps, flexible, with spring
26-00664	Kavrayıcı Forseps, yarı esnek , yaysız	26-00664	Grasping forceps, semi-rigid, without spring
26-00665	Kavrayıcı Forseps, yarı esnek , yaylı	26-00665	Grasping forceps, semi-rigid, with spring



26-00666	Kavrayıcı Forseps, esnek , yaysız	26-00666	Grasping forceps, flexible, without spring
26-00667	Kavrayıcı Forseps, esnek , yaylı	26-00667	Grasping forceps, flexible, with spring
26-00668	Kavrayıcı Forseps, yarı esnek , yaysız	26-00668	Grasping forceps, semi-rigid, without spring
26-00669	Kavrayıcı Forseps, yarı esnek , yaylı	26-00669	Grasping forceps, semi-rigid, with spring